

AC Filter, High Symmetrical Attenuation

new



Description

- Chassis:
Screw-on mounting, from top
- Line-filter in standard version, 1-stage, high attenuation
- High symmetrical attenuation in the frequency range from 10kHz up to 30MHz

Unique Selling Proposition

- Excellent symmetrical attenuation
- Compact and cost optimized
- Completely closed steel housing
- Optional wire leads

Approvals

- VDE Certificate Number: 40041643
- UL File Number: E72928

Characteristics

- Compact filter with high symmetrical attenuation
- Designed for universal industrial applications
- Especially designed for applications with symmetrical noise caused by switching semiconductors
- Suitable for use in equipment according to IEC/UL 60950
- Suitable for use in medical equipment according to IEC/UL 60601-1

Other versions on request

- Version with wire connection
- Medical version M80

Weblinks

[pdf-datasheet](#), [html-datasheet](#), [General Product Information](#), [Approvals](#), [CE declaration of conformity](#), [RoHS](#), [CHINA-RoHS](#), [REACH](#), [e-Shop](#), [SCHURTER-Stock-Check](#), [Distributor-Stock-Check](#), [Detailed request for product](#)

Technical Data

Ratings IEC	1 - 30A @ Ta 40 °C / 250VAC; 50Hz
Ratings UL/CSA	1 - 30A @ Ta 40 °C / 125/250VAC; 60Hz
Leakage Current	industrial < 1mA (250V / 60Hz)
Dielectric Strength	> 1.7 kVDC between L-N > 2.7 kVDC between L/N-PE Test voltage (2 sec)
Allowable Operation Temp.	-25 °C to 100 °C
Climatic Category	25/100/21 acc. to IEC 60068-1
Protection Class	Suitable for appliances with protection class I acc. to IEC 61140
Terminal	Quick connect terminal 6.3 x 0.8 mm Bolt and nut M4
Material: Housing	Metal

Line Filter	Standard, medical and industrial version, IEC 60939, UL 1283, CSA C22.2 no. 8 Technical Details
MTBF	> 200'000h acc. to MIL-HB-217 F

Dimension

Case PG with quick connect terminals

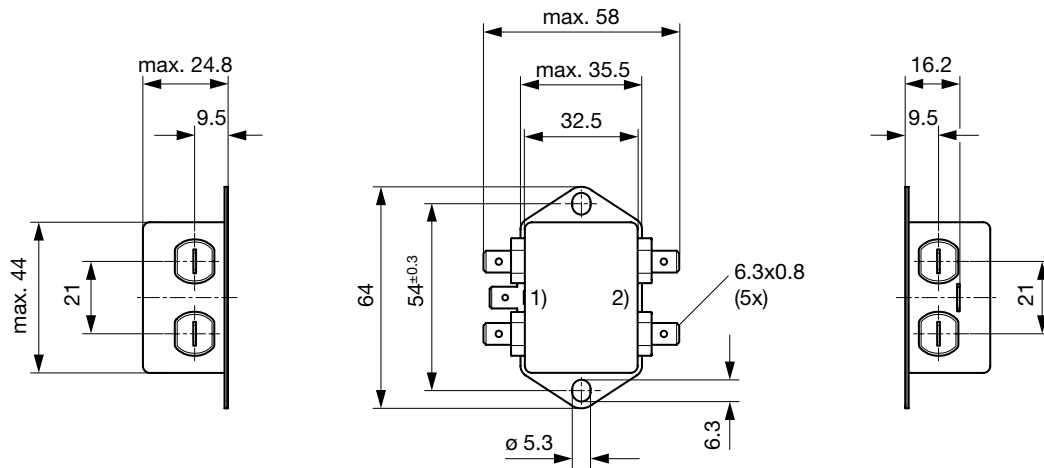

- 1) Line
- 2) Load

Case PH with quick connect terminals

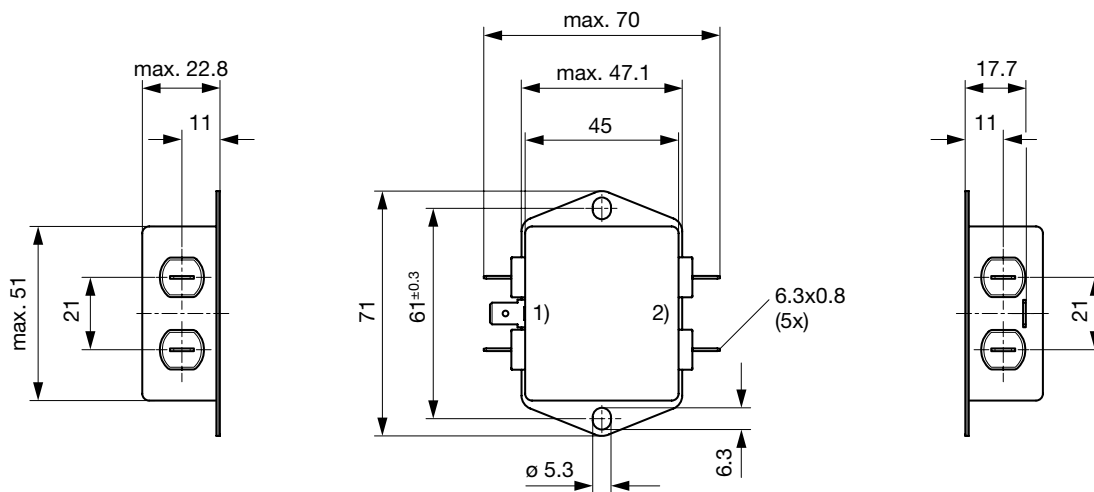

- 1) Line
- 2) Load

Case PI with quick connect terminals

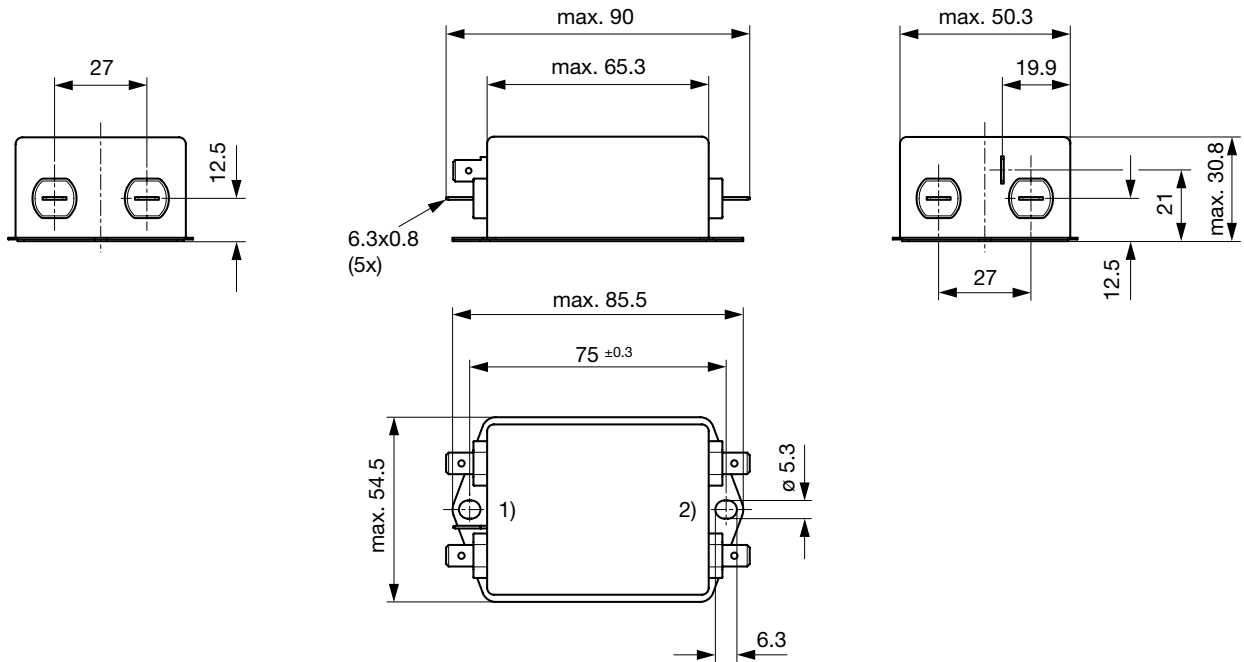

- 1) Line
- 2) Load

Case PK with quick connect terminals

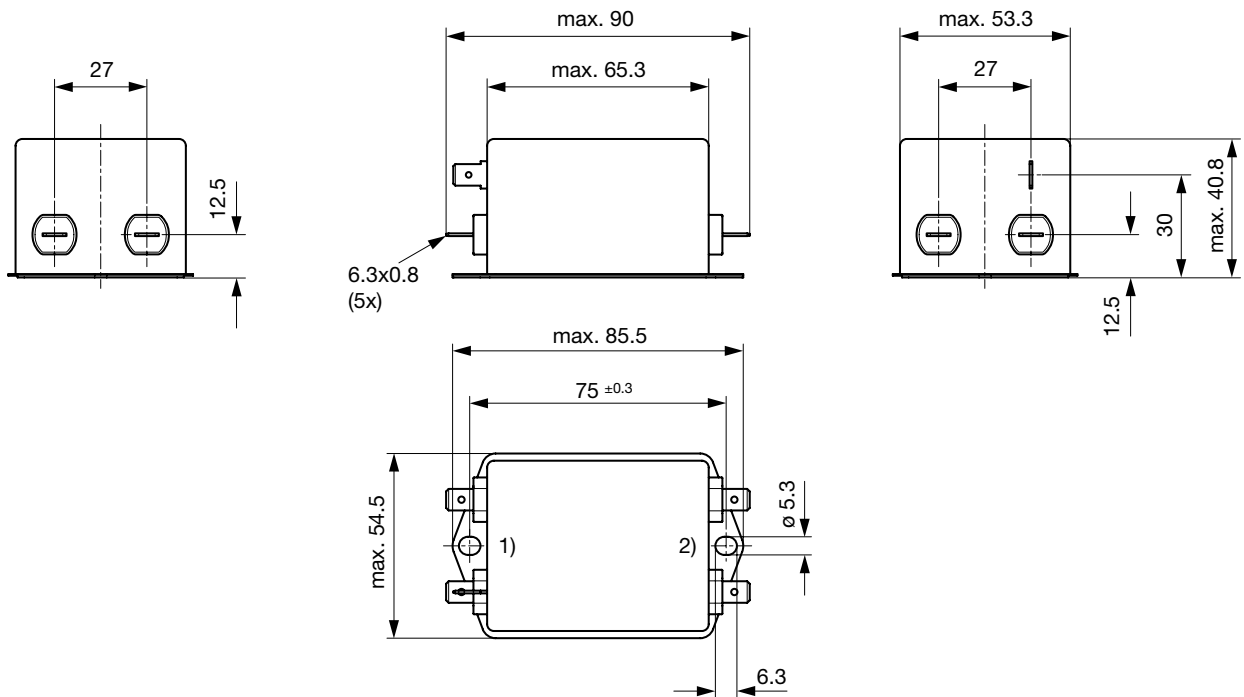

- 1) Line
- 2) Load

Case PK with bolt and nut

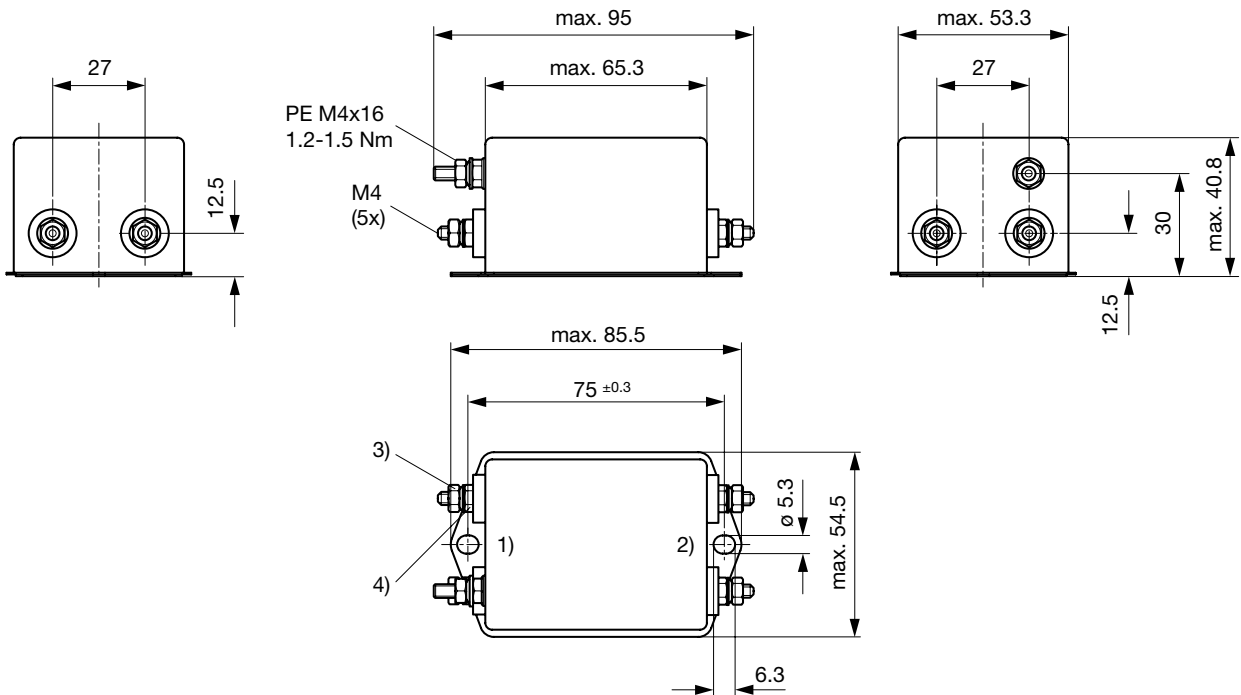

- 1) Line
- 2) Load
- 3) Nut torque 0.8...1 Nm, keep lock-nut fastened
- 4) Lock-nut do not unscrew

Diagrams

Standard version

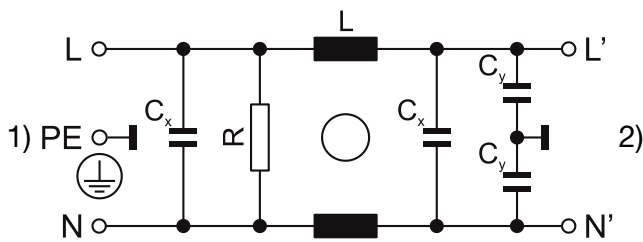

- 1) Line
- 2) Load

Medical version M5

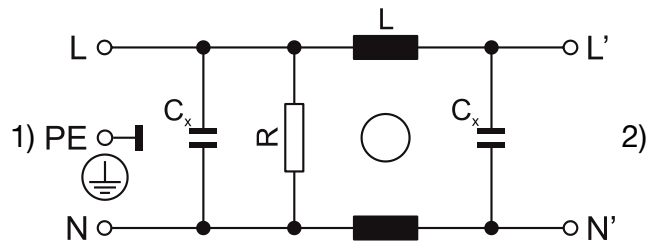

- 1) Line
- 2) Load

Attenuation Loss .. 0.1/100Ω differential mode 100/0.1Ω differential mode - - - - 50Ω differential mode ____ 50Ω common mode
 Standard version

1 A

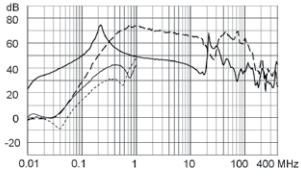

3 A

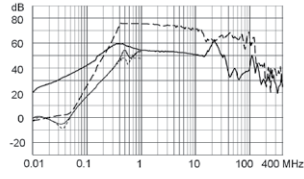

4 A

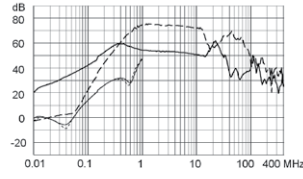

6 A

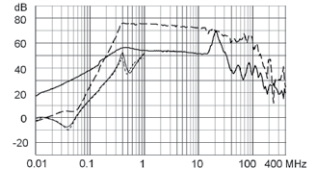

8 A

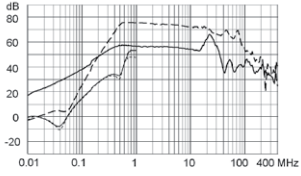

10 A

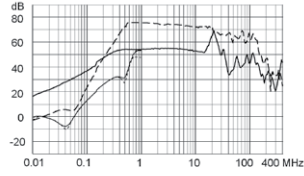

12 A

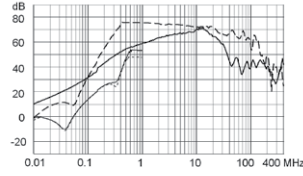

16 A

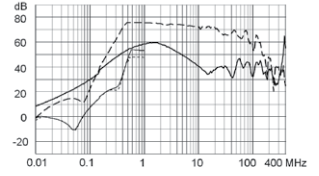

20 A

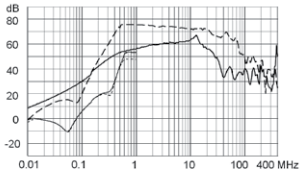

30 A

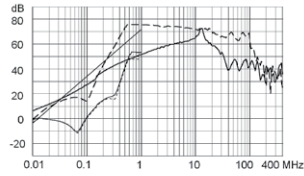

Medical version (M5)

1 A

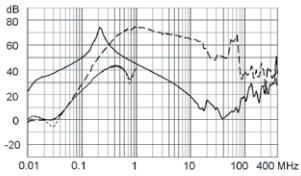

3 A

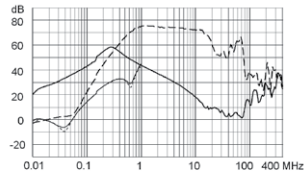

4 A

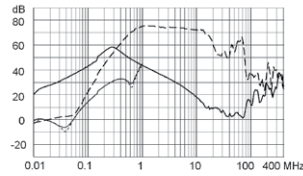

6 A

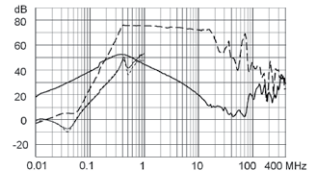

8 A

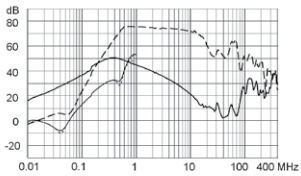

10 A

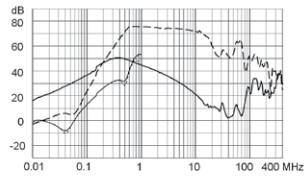

12 A

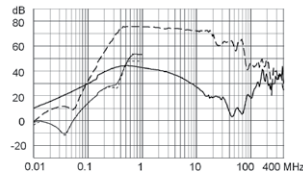

16 A

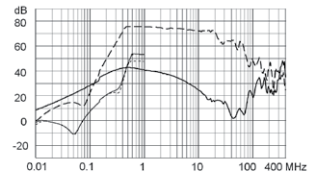

20 A

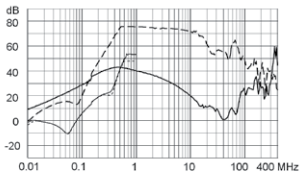

30 A

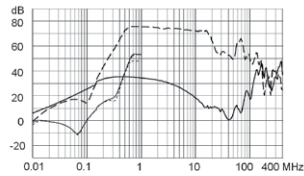

All Variants

Rated current	Filter-Type	Terminal	Design	Leakage	Ri	Power Loss	Weight	Housing	Packaging	Order Number
[A]				[mA]	[mΩ]	[W]	[g]		[ST]	
1	Standard Version	Quick connect terminal 6.3 x 0.8 mm	N	0.5	475	1	72 g	PG	15	5500.2630.01
3	Standard Version	Quick connect terminal 6.3 x 0.8 mm	N	0.5	83	1.5	104 g	PH	15	5500.2631.01
4	Standard Version	Quick connect terminal 6.3 x 0.8 mm	N	0.5	53	1.7	108 g	PH	15	5500.2632.01
6	Standard Version	Quick connect terminal 6.3 x 0.8 mm	N	0.5	32.5	2.4	109 g	PH	15	5500.2633.01
8	Standard Version	Quick connect terminal 6.3 x 0.8 mm	N	0.5	29.2	3.8	190 g	PI	10	5500.2634.01
10	Industrial Version	Quick connect terminal 6.3 x 0.8 mm	N	1	22.8	4.6	200 g	PI	10	5500.2635.01
12	Industrial Version	Quick connect terminal 6.3 x 0.8 mm	N	1	13.2	3.8	201 g	PI	10	5500.2636.01
16	Industrial Version	Quick connect terminal 6.3 x 0.8 mm	N	1	7.2	3.7	308 g	PK	10	5500.2637.01
20	Industrial Version	Quick connect terminal 6.3 x 0.8 mm	N	1	6.0	4.8	322 g	PK	10	5500.2638.01
30	Industrial Version	Bolt and nut M4	N	1	2.9	5.2	355 g	PK	10	5500.2639.03
1	Medical (M5)	Quick connect terminal 6.3 x 0.8 mm	N	0.005	475	1	72 g	PG	15	5500.2630.04
3	Medical (M5)	Quick connect terminal 6.3 x 0.8 mm	N	0.005	83	1.5	104 g	PH	15	5500.2631.04
4	Medical (M5)	Quick connect terminal 6.3 x 0.8 mm	N	0.005	53	1.7	108 g	PH	15	5500.2632.04
6	Medical (M5)	Quick connect terminal 6.3 x 0.8 mm	N	0.005	32.5	2.4	109 g	PH	15	5500.2633.04
8	Medical (M5)	Quick connect terminal 6.3 x 0.8 mm	N	0.005	29.2	3.8	190 g	PI	10	5500.2634.04
10	Medical (M5)	Quick connect terminal 6.3 x 0.8 mm	N	0.005	22.8	4.6	200 g	PI	10	5500.2635.04
12	Medical (M5)	Quick connect terminal 6.3 x 0.8 mm	N	0.005	13.2	3.8	201 g	PI	10	5500.2636.04
16	Medical (M5)	Quick connect terminal 6.3 x 0.8 mm	N	0.005	7.2	3.7	308 g	PK	10	5500.2637.04
20	Medical (M5)	Quick connect terminal 6.3 x 0.8 mm	N	0.005	6.0	4.8	322 g	PK	10	5500.2638.04
30	Medical (M5)	Bolt and nut M4	N	0.005	2.9	5.2	355 g	PK	10	5500.2639.06

Availability for all products can be searched real-time: <http://www.schurter.com/en/Stock-Check/Stock-Check-SCHURTER>